

CG2H40025

25 W, RF Power GaN HEMT

Cree's CG2H40025 is an unmatched, gallium nitride (GaN) high electron mobility transistor (HEMT). The CG2H40025, operating from a 28 volt rail, offers a general purpose, broadband solution to a variety of RF and microwave applications. GaN HEMTs offer high efficiency, high gain and wide bandwidth capabilities making the CG2H40025 ideal for linear and compressed amplifier circuits. The transistor is available in a screw-down, flange package and solder-down, pill packages.

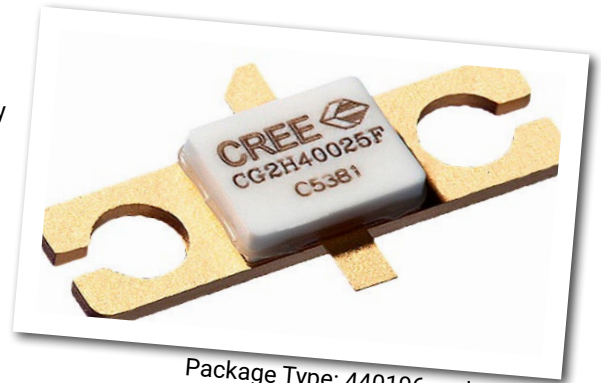

Package Type: 440196 and 440166
PN: CG2H40025P and CG2H40025F

FEATURES

- Up to 6 GHz Operation
- 17 dB Small Signal Gain at 2.0 GHz
- 15 dB Small Signal Gain at 4.0 GHz
- 30 W typical P_{SAT}
- 65 % Efficiency at P_{SAT}
- 28 V Operation

APPLICATIONS

- 2-Way Private Radio
- Broadband Amplifiers
- Cellular Infrastructure
- Test Instrumentation
- Class A, AB, Linear amplifiers suitable for OFDM, W-CDMA, EDGE, CDMA waveforms



Absolute Maximum Ratings (not simultaneous) at 25°C Case Temperature

Parameter	Symbol	Rating	Units	Conditions
Drain-Source Voltage	V_{DSS}	120	Volts	25°C
Gate-to-Source Voltage	V_{GS}	-10, +2	Volts	25°C
Storage Temperature	T_{STG}	-65, +150	°C	
Operating Junction Temperature	T_J	225	°C	
Maximum Forward Gate Current	I_{GMAX}	7.0	mA	25°C
Maximum Drain Current ¹	I_{DMAX}	3	A	25°C
Soldering Temperature ²	T_S	245	°C	
Screw Torque	τ	60	in-oz	
Thermal Resistance, Junction to Case ³	R_{JJC}	4.8	°C/W	85°C
Case Operating Temperature ^{3,4}	T_C	-40, +150	°C	

Note:

¹ Current limit for long term, reliable operation

² Refer to the Application Note on soldering at www.cree.com/RF/Document-Library

³ Measured for the CG2H40025F at $P_{DISS} = 28$ W.

⁴ See also, the Power Dissipation De-rating Curve on Page 6.

Electrical Characteristics ($T_C = 25^\circ\text{C}$)

Characteristics	Symbol	Min.	Typ.	Max.	Units	Conditions
DC Characteristics¹						
Gate Threshold Voltage	$V_{GS(th)}$	-3.8	-3.0	-2.3	V_{DC}	$V_{DS} = 10$ V, $I_D = 7.2$ mA
Gate Quiescent Voltage	$V_{GS(Q)}$	-	-2.7	-	V_{DC}	$V_{DS} = 28$ V, $I_D = 250$ mA
Saturated Drain Current	I_{DS}	5.8	7.0	-	A	$V_{DS} = 6.0$ V, $V_{GS} = 2.0$ V
Drain-Source Breakdown Voltage	V_{BR}	120	-	-	V_{DC}	$V_{GS} = -8$ V, $I_D = 7.2$ mA
RF Characteristics² ($T_C = 25^\circ\text{C}$, $F_0 = 3.7$ GHz unless otherwise noted)						
Small Signal Gain	G_{SS}	14	15	-	dB	$V_{DD} = 28$ V, $I_{DQ} = 250$ mA
Power Output ³	P_{SAT}	20	30	-	W	$V_{DD} = 28$ V, $I_{DQ} = 250$ mA
Drain Efficiency ⁴	η	55	65	-	%	$V_{DD} = 28$ V, $I_{DQ} = 250$ mA, P_{SAT}
Output Mismatch Stress	VSWR	-	-	10 : 1	Ψ	No damage at all phase angles, $V_{DD} = 28$ V, $I_{DQ} = 250$ mA, $P_{OUT} = 25$ W CW
Dynamic Characteristics						
Input Capacitance	C_{GS}	-	7.5	-	pF	$V_{DS} = 28$ V, $V_{GS} = -8$ V, $f = 1$ MHz
Output Capacitance	C_{DS}	-	2.4	-	pF	$V_{DS} = 28$ V, $V_{GS} = -8$ V, $f = 1$ MHz
Feedback Capacitance	C_{GD}	-	0.4	-	pF	$V_{DS} = 28$ V, $V_{GS} = -8$ V, $f = 1$ MHz

Notes:

¹ Measured on wafer prior to packaging.

² Measured in CG2H40025-AMP.

³ P_{SAT} is defined as $I_G = 0.72$ mA.

⁴ Drain Efficiency = P_{OUT} / P_{DC}

Typical Performance

Small Signal Gain and Return Loss vs Frequency of the CG2H40025F in the CG2H40025-AMP

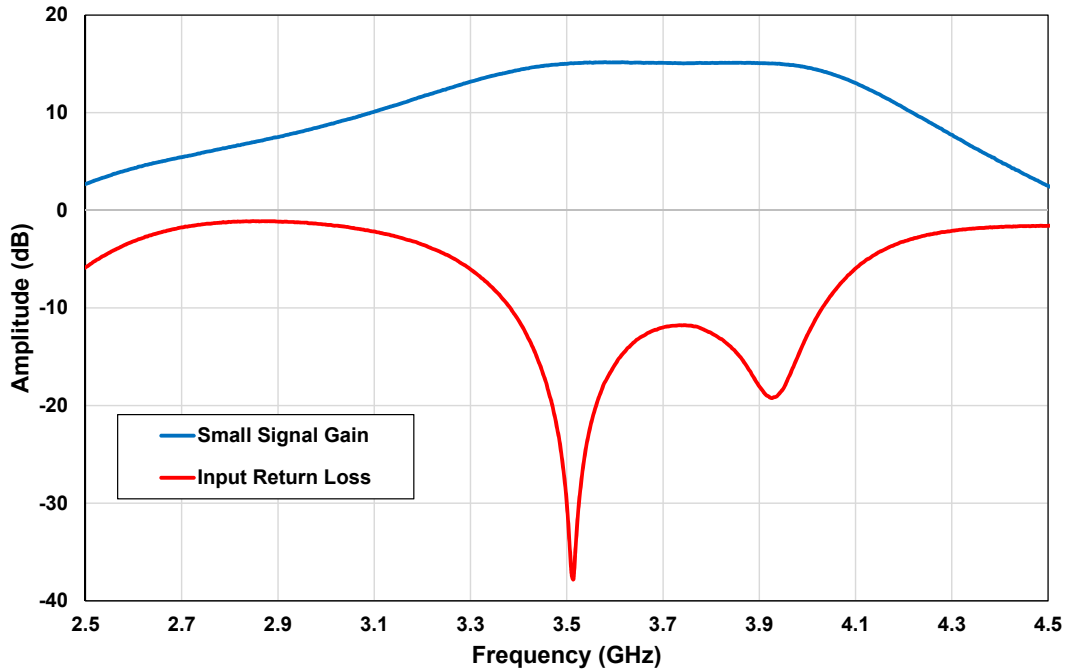

P_{SAT} Gain, and Drain Efficiency vs Frequency of the CG2H40025F in the CG2H40025-AMP
 $V_{DD} = 28\text{ V}$, $I_{DQ} = 250\text{ mA}$

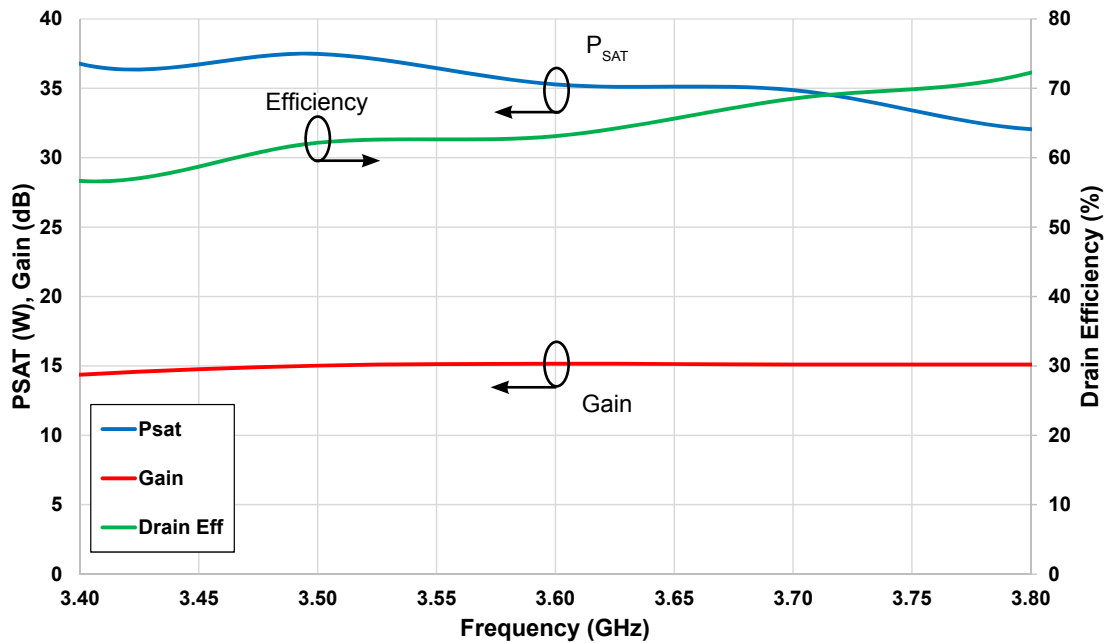

Typical Performance

Swept CW Data of CG2H40025 vs. Output Power with Source and Load Impedances Optimized for P_{SAT} Power in CG2H40025-AMP

$V_{DD} = 28\text{ V}$, $I_{DQ} = 250\text{ mA}$, Freq = 3.7 GHz

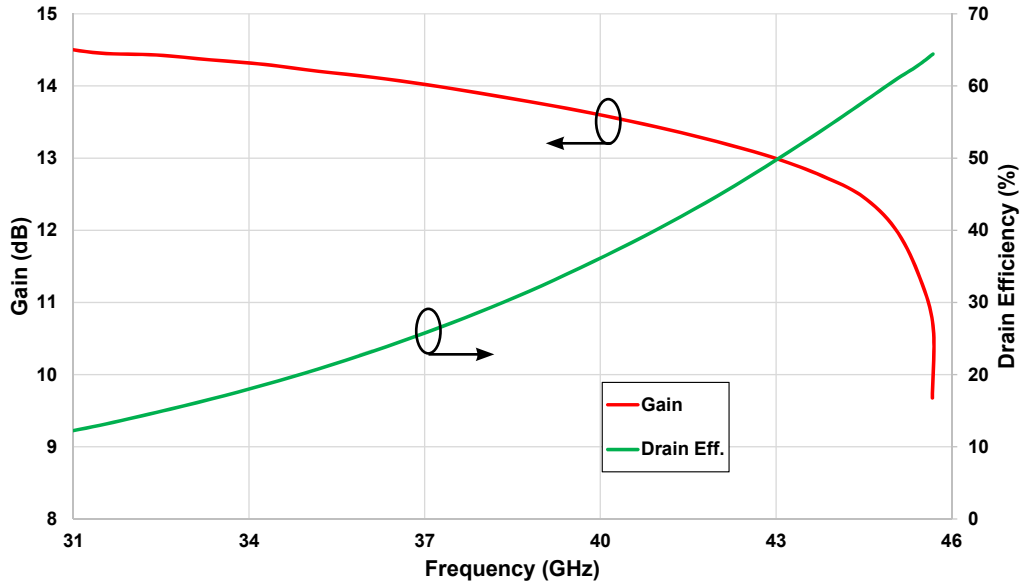

Maximum Available Gain and K Factor of the CG2H40025

$V_{DD} = 28\text{ V}$, $I_{DQ} = 250\text{ mA}$

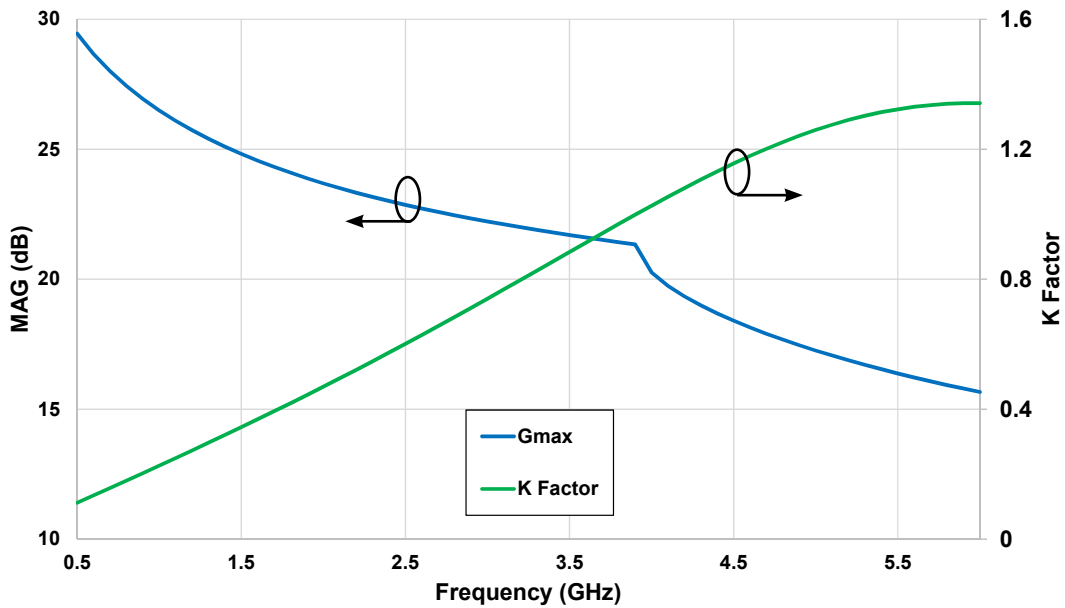

Typical Noise Performance

Simulated Minimum Noise Figure and Noise Resistance vs Frequency of the CG2H40025F
 $V_{DD} = 28\text{ V}$, $I_{DQ} = 250\text{ mA}$

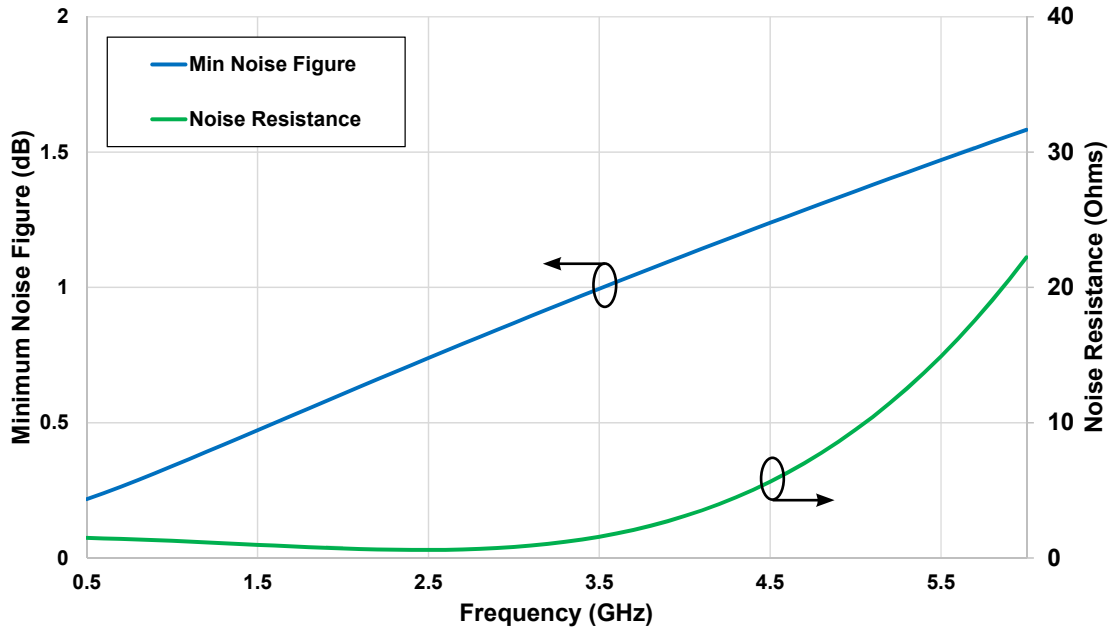

Electrostatic Discharge (ESD) Classifications

Parameter	Symbol	Class	Test Methodology
Human Body Model	HBM	1A > 250 V	JEDEC JESD22 A114-D
Charge Device Model	CDM	1 < 200 V	JEDEC JESD22 C101-C

Source and Load Impedances



Frequency (MHz)	Z Source	Z Load
500	7.75 + j15.5	20 + j5.2
1000	3.11 + j5.72	17 + j6.66
1500	2.86 + j1.63	16.8 + j3.2
2500	2.4 - j3.52	8.02 + j4.32
3500	1.31 - j7.3	5.85 - j0.51

Note 1. $V_{DD} = 28V$, $I_{DQ} = 250mA$ in the 440166 package.

Note 2. Optimized for power gain, P_{SAT} and PAE.

Note 3. When using this device at low frequency, series resistors should be used to maintain amplifier stability.

CG2H40025 Power Dissipation De-rating Curve

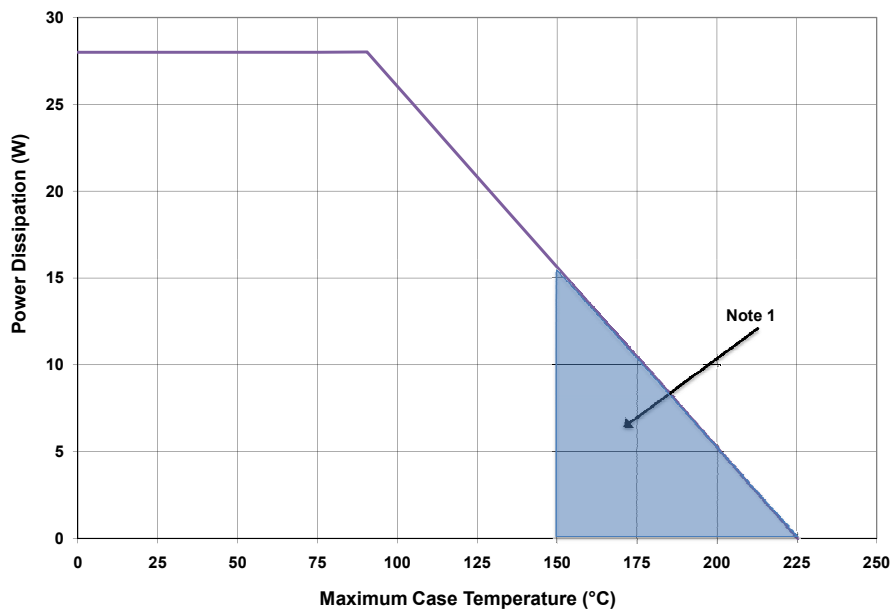

Note 1. Area exceeds Maximum Case Operating Temperature (See Page 2).

CG2H40025-AMP Demonstration Amplifier Circuit Schematic

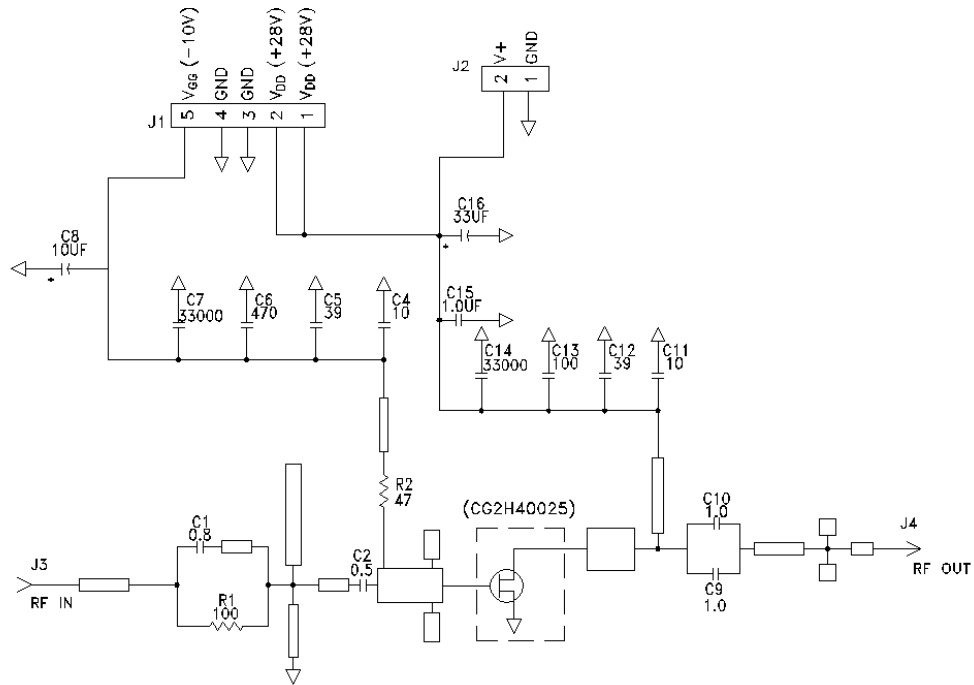

CG2H40025-AMP Demonstration Amplifier Circuit Outline

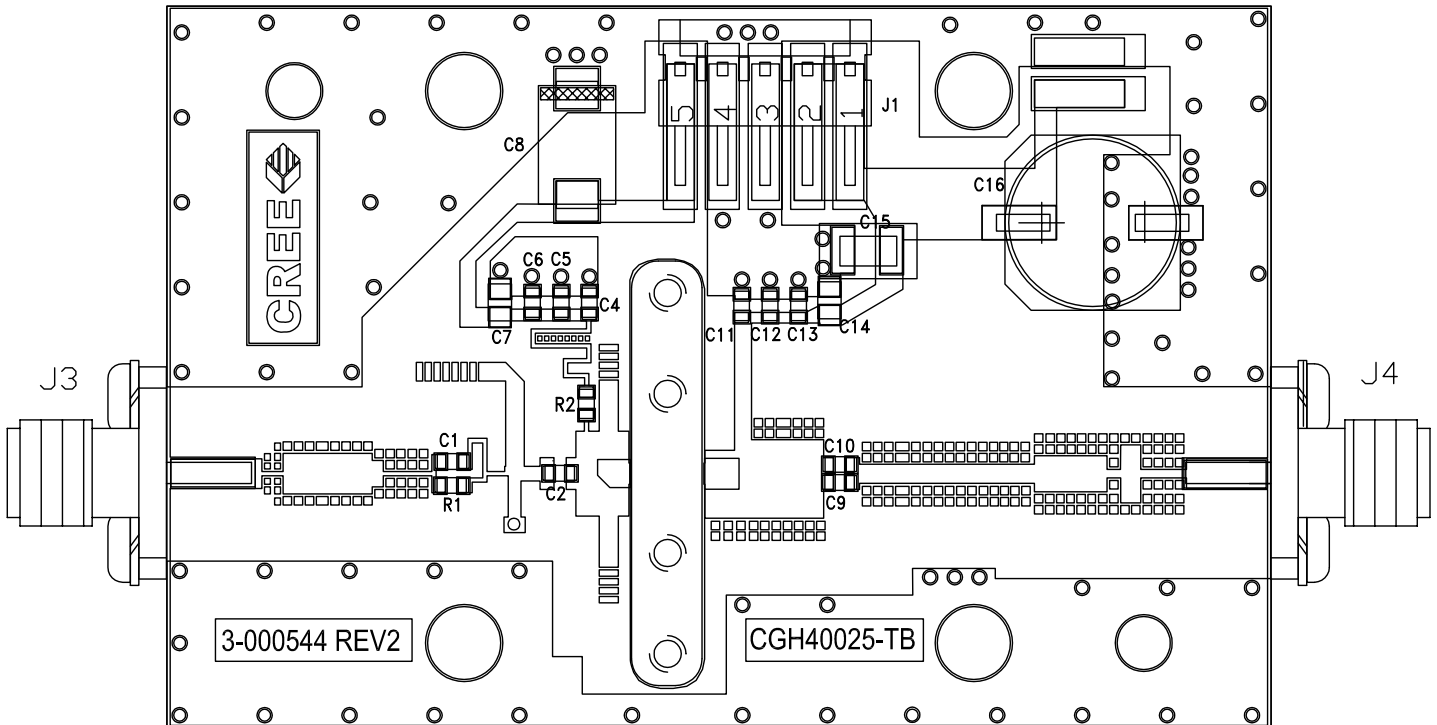

CG2H40025-AMP Demonstration Amplifier Circuit Bill of Materials

Designator	Description	Qty
R2	RES,1/16W,0603,1%,47 OHMS	1
R1	RES,1/16W,0603,1%,100 OHMS	1
C6	CAP, 470PF, 5%,100V, 0603	1
C16	CAP, 33 UF, 20%, G CASE	1
C15	CAP, 1.0UF, 100V, 10%, X7R, 1210	1
C8	CAP 10UF 16V TANTALUM	1
C13	CAP, 100.0pF, +/-5%, 0603	1
C1	CAP, 0.8pF, +/-0.1pF, 0603	1
C2	CAP, 0.5pF, +/-0.05pF, 0603	1
C9,C10	CAP, 1.0pF, +/-0.1pF, 0603	2
C4,C11	CAP, 10.0pF,+/-5%, 0603	2
C5,C12	CAP, 39pF, +/-5%, 0603	2
C7,C14	CAP,33000PF, 0805,100V, X7R	2
J3,J4	CONN SMA STR PANEL JACK RECP	2
J1	HEADER RT>PLZ .1CEN LK 5POS	1
-	PCB, RO4350B, Er = 3.48, h = 20 mil	1
-	CG2H40025F or CG2H40025P	1

CG2H40025F-AMP Demonstration Amplifier Circuit

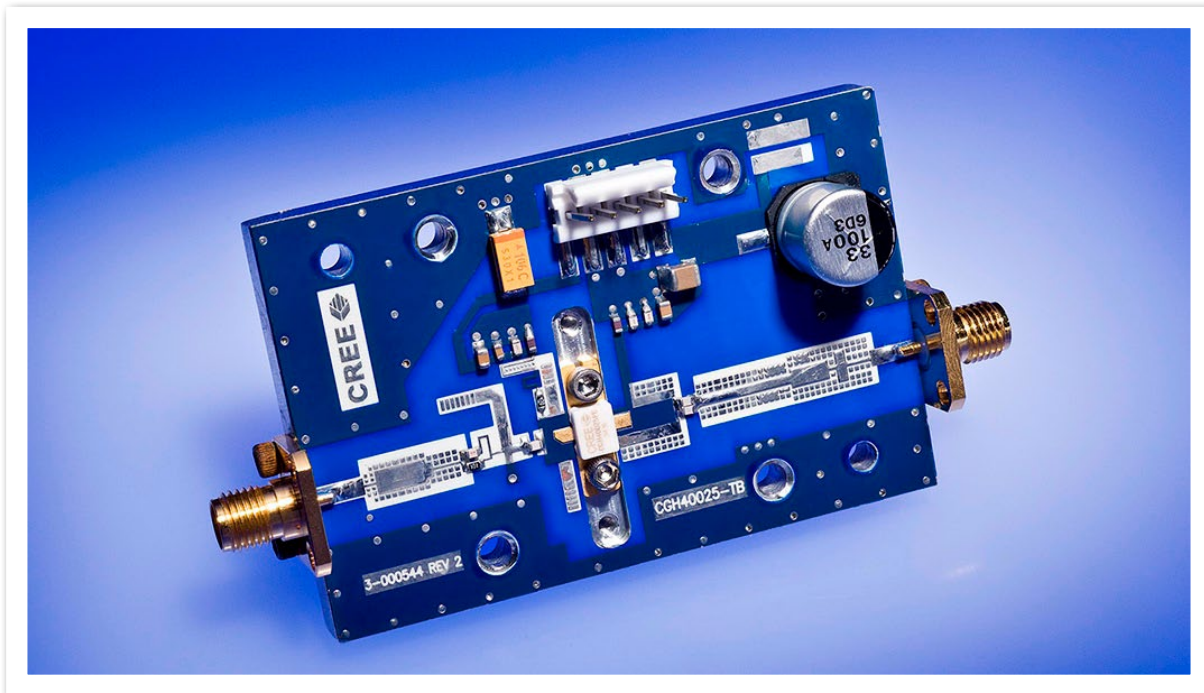



Typical Package S-Parameters for CG2H40025
 (Small Signal, $V_{DS} = 28\text{ V}$, $I_{DQ} = 100\text{ mA}$, angle in degrees)

Frequency	Mag S11	Ang S11	Mag S21	Ang S21	Mag S12	Ang S12	Mag S22	Ang S22
0.5	0.88499	-149.28	14.898	95.505	0.027084	8.7483	0.49738	-148.88
0.6	0.88261	-155.31	12.533	90.905	0.027273	4.8054	0.50241	-153.23
0.7	0.8814	-159.89	10.792	87.004	0.027319	1.5653	0.50734	-156.33
0.8	0.88088	-163.52	9.4603	83.556	0.027276	-1.2165	0.51241	-158.65
0.9	0.88081	-166.51	8.4095	80.419	0.027173	-3.681	0.51774	-160.46
1	0.88104	-169.05	7.5594	77.507	0.027024	-5.9148	0.52336	-161.92
1.1	0.88151	-171.26	6.8576	74.762	0.026839	-7.9731	0.52928	-163.15
1.2	0.88215	-173.22	6.2682	72.148	0.026623	-9.8931	0.5355	-164.2
1.3	0.88293	-174.99	5.7662	69.638	0.026381	-11.7	0.54199	-165.14
1.4	0.88382	-176.6	5.3332	67.212	0.026116	-13.412	0.54872	-166
1.5	0.88481	-178.1	4.9559	64.858	0.02583	-15.041	0.55567	-166.8
1.6	0.88588	-179.5	4.624	62.565	0.025526	-16.598	0.56281	-167.57
1.7	0.88701	179.18	4.3298	60.326	0.025204	-18.088	0.57009	-168.31
1.8	0.88821	177.92	4.0671	58.133	0.024867	-19.516	0.5775	-169.04
1.9	0.88945	176.71	3.8311	55.984	0.024515	-20.887	0.585	-169.77
2	0.89073	175.55	3.6178	53.873	0.024151	-22.202	0.59257	-170.51
2.1	0.89204	174.43	3.4242	51.797	0.023775	-23.463	0.60019	-171.25
2.2	0.89338	173.34	3.2476	49.755	0.023388	-24.672	0.60781	-171.99
2.3	0.89474	172.27	3.0859	47.744	0.022992	-25.828	0.61543	-172.75
2.4	0.89612	171.23	2.9373	45.763	0.022587	-26.933	0.62303	-173.52
2.5	0.89751	170.21	2.8002	43.81	0.022175	-27.985	0.63058	-174.3
2.6	0.89891	169.2	2.6735	41.883	0.021757	-28.985	0.63807	-175.1
2.7	0.90031	168.21	2.5559	39.982	0.021334	-29.932	0.64549	-175.91
2.8	0.9017	167.23	2.4465	38.105	0.020906	-30.824	0.65282	-176.73
2.9	0.9031	166.25	2.3446	36.252	0.020474	-31.66	0.66005	-177.57
3	0.90449	165.29	2.2494	34.422	0.020041	-32.439	0.66717	-178.42
3.2	0.90724	163.39	2.0768	30.828	0.019169	-33.818	0.68106	179.85
3.4	0.90993	161.5	1.9245	27.316	0.018299	-34.946	0.69442	178.08
3.6	0.91255	159.63	1.7893	23.882	0.017437	-35.802	0.70724	176.27
3.8	0.91508	157.78	1.6687	20.522	0.01659	-36.365	0.71948	174.43
4	0.91753	155.92	1.5605	17.231	0.015767	-36.609	0.73115	172.55
4.2	0.91988	154.07	1.4631	14.006	0.014976	-36.507	0.74223	170.66
4.4	0.92214	152.22	1.3751	10.841	0.014224	-36.031	0.75275	168.74
4.6	0.92429	150.37	1.2952	7.735	0.01352	-35.155	0.76271	166.81
4.8	0.92634	148.52	1.2225	4.6828	0.012876	-33.855	0.77213	164.85
5	0.92829	146.66	1.1562	1.6815	0.012301	-32.122	0.78103	162.89
5.2	0.93014	144.79	1.0955	-1.2722	0.011806	-29.957	0.78944	160.91
5.4	0.9319	142.92	1.0399	-4.1815	0.011402	-27.388	0.79738	158.92
5.6	0.93356	141.04	0.98868	-7.0492	0.011098	-24.468	0.80486	156.92
5.8	0.93513	139.15	0.94152	-9.8782	0.010902	-21.282	0.81193	154.92
6	0.93661	137.25	0.89796	-12.671	0.010821	-17.938	0.81859	152.9

Typical Package S-Parameters for CG2H40025
 (Small Signal, $V_{DS} = 28\text{ V}$, $I_{DQ} = 250\text{ mA}$, angle in degrees)

Frequency	Mag S11	Ang S11	Mag S21	Ang S21	Mag S12	Ang S12	Mag S22	Ang S22
0.5	0.90491	-156.21	16.477	94.241	0.018693	9.2168	0.58893	-164.26
0.6	0.90353	-161.33	13.824	90.4	0.018786	6.3828	0.59428	-167.21
0.7	0.90278	-165.23	11.891	87.143	0.018813	4.1397	0.59824	-169.41
0.8	0.90239	-168.36	10.423	84.261	0.0188	2.2779	0.60153	-171.14
0.9	0.90223	-170.96	9.2712	81.632	0.01876	0.67825	0.60449	-172.55
1	0.90222	-173.19	8.3431	79.185	0.0187	-0.73148	0.60732	-173.74
1.1	0.90233	-175.15	7.5795	76.871	0.018624	-1.9974	0.61011	-174.77
1.2	0.90253	-176.91	6.9403	74.659	0.018534	-3.15	0.61293	-175.69
1.3	0.90279	-178.51	6.3972	72.527	0.018434	-4.2101	0.61581	-176.53
1.4	0.90311	-179.98	5.93	70.459	0.018323	-5.1924	0.61877	-177.3
1.5	0.90348	178.64	5.5237	68.444	0.018203	-6.107	0.62182	-178.03
1.6	0.90389	177.34	5.1671	66.473	0.018075	-6.9615	0.62496	-178.72
1.7	0.90433	176.11	4.8515	64.54	0.01794	-7.761	0.6282	-179.39
1.8	0.90481	174.93	4.5702	62.64	0.017798	-8.5096	0.63154	179.96
1.9	0.90531	173.8	4.3179	60.768	0.01765	-9.2098	0.63496	179.33
2	0.90585	172.7	4.0901	58.922	0.017496	-9.8635	0.63847	178.7
2.1	0.9064	171.63	3.8836	57.1	0.017337	-10.472	0.64206	178.07
2.2	0.90697	170.59	3.6954	55.298	0.017174	-11.036	0.64571	177.45
2.3	0.90757	169.58	3.5231	53.515	0.017007	-11.556	0.64943	176.83
2.4	0.90818	168.58	3.3648	51.751	0.016838	-12.032	0.65321	176.21
2.5	0.9088	167.6	3.2189	50.004	0.016665	-12.464	0.65704	175.58
2.6	0.90944	166.64	3.084	48.272	0.016491	-12.851	0.6609	174.95
2.7	0.91009	165.69	2.9588	46.555	0.016315	-13.193	0.66481	174.31
2.8	0.91075	164.75	2.8423	44.853	0.016139	-13.49	0.66874	173.66
2.9	0.91142	163.81	2.7337	43.165	0.015962	-13.741	0.67269	173
3	0.9121	162.89	2.6322	41.489	0.015786	-13.945	0.67666	172.34
3.2	0.91346	161.06	2.4478	38.177	0.015439	-14.21	0.68461	170.99
3.4	0.91485	159.25	2.2847	34.911	0.015102	-14.282	0.69255	169.6
3.6	0.91623	157.45	2.1395	31.691	0.014781	-14.157	0.70045	168.18
3.8	0.91762	155.66	2.0094	28.514	0.014482	-13.834	0.70825	166.72
4	0.91899	153.87	1.8923	25.377	0.01421	-13.317	0.71595	165.23
4.2	0.92035	152.09	1.7863	22.279	0.013971	-12.612	0.7235	163.7
4.4	0.92169	150.31	1.69	19.217	0.013771	-11.731	0.73088	162.14
4.6	0.923	148.52	1.6022	16.191	0.013614	-10.692	0.73809	160.55
4.8	0.92428	146.73	1.5219	13.198	0.013506	-9.5178	0.74511	158.93
5	0.92553	144.93	1.4481	10.238	0.01345	-8.2372	0.75193	157.28
5.2	0.92675	143.12	1.3802	7.3068	0.01345	-6.8834	0.75854	155.6
5.4	0.92793	141.31	1.3176	4.4046	0.013508	-5.4927	0.76493	153.9
5.6	0.92908	139.48	1.2597	1.5294	0.013626	-4.1024	0.77111	152.17
5.8	0.93018	137.65	1.206	-1.3203	0.013803	-2.7494	0.77708	150.42
6	0.93125	135.8	1.1561	-4.1462	0.014039	-1.4677	0.78283	148.65

To download the s-parameters in s2p format, go to the [CGH40025 Product Page](#) and click on the documentation tab.

Typical Package S-Parameters for CG2H40025
 (Small Signal, $V_{DS} = 28\text{ V}$, $I_{DQ} = 400\text{ mA}$, angle in degrees)

Frequency	Mag S11	Ang S11	Mag S21	Ang S21	Mag S12	Ang S12	Mag S22	Ang S22
0.5	0.91411	-158.63	16.661	93.602	0.015946	9.5249	0.61632	-168.1
0.6	0.91304	-163.41	13.965	90	0.016016	7.1218	0.62117	-170.62
0.7	0.91246	-167.07	12.007	86.941	0.01604	5.2677	0.62463	-172.53
0.8	0.91214	-170.01	10.523	84.227	0.016035	3.767	0.62741	-174.06
0.9	0.912	-172.47	9.3601	81.748	0.016012	2.5091	0.62983	-175.33
1	0.91197	-174.59	8.4243	79.434	0.015975	1.4271	0.63209	-176.43
1.1	0.91203	-176.46	7.6551	77.243	0.015927	0.47849	0.63429	-177.4
1.2	0.91215	-178.14	7.0117	75.144	0.015871	-0.36499	0.63647	-178.27
1.3	0.91232	-179.67	6.4654	73.119	0.015808	-1.1225	0.63869	-179.08
1.4	0.91253	178.9	5.9958	71.152	0.015738	-1.8074	0.64096	-179.83
1.5	0.91277	177.57	5.5877	69.232	0.015663	-2.4292	0.64329	179.45
1.6	0.91305	176.31	5.2297	67.352	0.015582	-2.9947	0.64569	178.77
1.7	0.91335	175.1	4.9131	65.506	0.015498	-3.509	0.64816	178.11
1.8	0.91368	173.95	4.631	63.689	0.01541	-3.9755	0.65071	177.46
1.9	0.91403	172.84	4.378	61.897	0.015318	-4.3969	0.65333	176.83
2	0.91439	171.76	4.1499	60.128	0.015224	-4.7751	0.65603	176.2
2.1	0.91478	170.72	3.943	58.378	0.015128	-5.1114	0.65879	175.58
2.2	0.91518	169.69	3.7545	56.647	0.01503	-5.4068	0.66162	174.96
2.3	0.91559	168.69	3.5821	54.933	0.01493	-5.6617	0.6645	174.34
2.4	0.91602	167.71	3.4238	53.234	0.014831	-5.8768	0.66744	173.73
2.5	0.91646	166.74	3.2779	51.549	0.01473	-6.0522	0.67043	173.11
2.6	0.91691	165.79	3.1429	49.878	0.014631	-6.1881	0.67347	172.48
2.7	0.91737	164.84	3.0178	48.219	0.014532	-6.2847	0.67655	171.85
2.8	0.91784	163.91	2.9014	46.572	0.014434	-6.342	0.67966	171.22
2.9	0.91832	162.99	2.7928	44.937	0.014339	-6.3603	0.6828	170.58
3	0.9188	162.07	2.6914	43.313	0.014246	-6.3396	0.68597	169.94
3.2	0.91979	160.25	2.5071	40.096	0.014069	-6.1828	0.69237	168.63
3.4	0.92079	158.46	2.3442	36.918	0.01391	-5.8752	0.69882	167.28
3.6	0.92181	156.67	2.1991	33.777	0.013772	-5.4232	0.70528	165.91
3.8	0.92283	154.89	2.069	30.671	0.01366	-4.8358	0.71174	164.51
4	0.92384	153.12	1.9519	27.598	0.013578	-4.1254	0.71815	163.08
4.2	0.92486	151.35	1.8459	24.558	0.01353	-3.3083	0.7245	161.61
4.4	0.92586	149.58	1.7494	21.547	0.013519	-2.4038	0.73077	160.12
4.6	0.92686	147.8	1.6615	18.565	0.01355	-1.4342	0.73694	158.59
4.8	0.92783	146.02	1.5809	15.611	0.013624	-0.42447	0.743	157.04
5	0.92879	144.23	1.5068	12.683	0.013743	0.59953	0.74893	155.45
5.2	0.92973	142.44	1.4386	9.7806	0.013909	1.6115	0.75473	153.84
5.4	0.93065	140.64	1.3756	6.9015	0.014122	2.5859	0.76038	152.2
5.6	0.93154	138.82	1.3172	4.0448	0.014382	3.4993	0.76588	150.54
5.8	0.93241	137	1.263	1.2093	0.014688	4.3307	0.77123	148.85
6	0.93325	135.16	1.2126	-1.6063	0.01504	5.0626	0.77642	147.14

Product Dimensions CG2H40025F (Package Type – 440166)

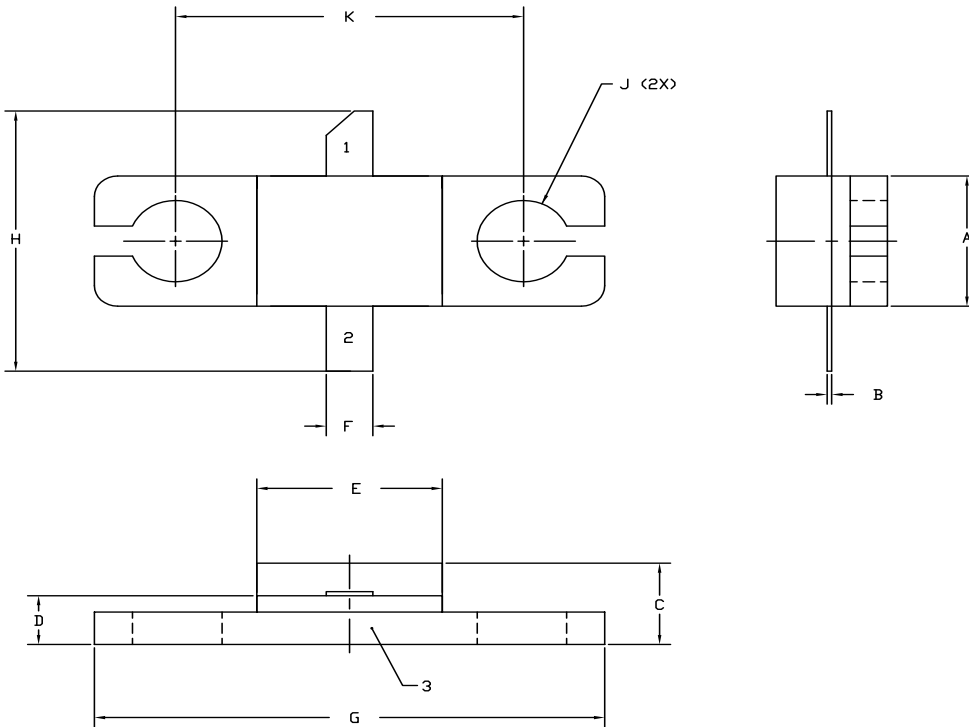

NOTES:

1. DIMENSIONING AND TOLERANCING PER ANSI Y14.5M, 1982.
2. CONTROLLING DIMENSION: INCH.
3. ADHESIVE FROM LID MAY EXTEND A MAXIMUM OF 0.020" BEYOND EDGE OF LID.
4. LID MAY BE MISALIGNED TO THE BODY OF THE PACKAGE BY A MAXIMUM OF 0.008" IN ANY DIRECTION.
5. ALL PLATED SURFACES ARE NI/AU

DIM	INCHES		MILLIMETERS	
	MIN	MAX	MIN	MAX
A	0.155	0.165	3.94	4.19
B	0.004	0.006	0.10	0.15
C	0.115	0.135	2.92	3.43
D	0.057	0.067	1.45	1.70
E	0.195	0.205	4.95	5.21
F	0.045	0.055	1.14	1.40
G	0.545	0.555	13.84	14.09
H	0.280	0.360	7.11	9.14
J	∅ .100		2.54	
K	0.375		9.53	

- PIN 1. GATE
 PIN 2. DRAIN
 PIN 3. SOURCE

Product Dimensions CG2H40025P (Package Type – 440196)

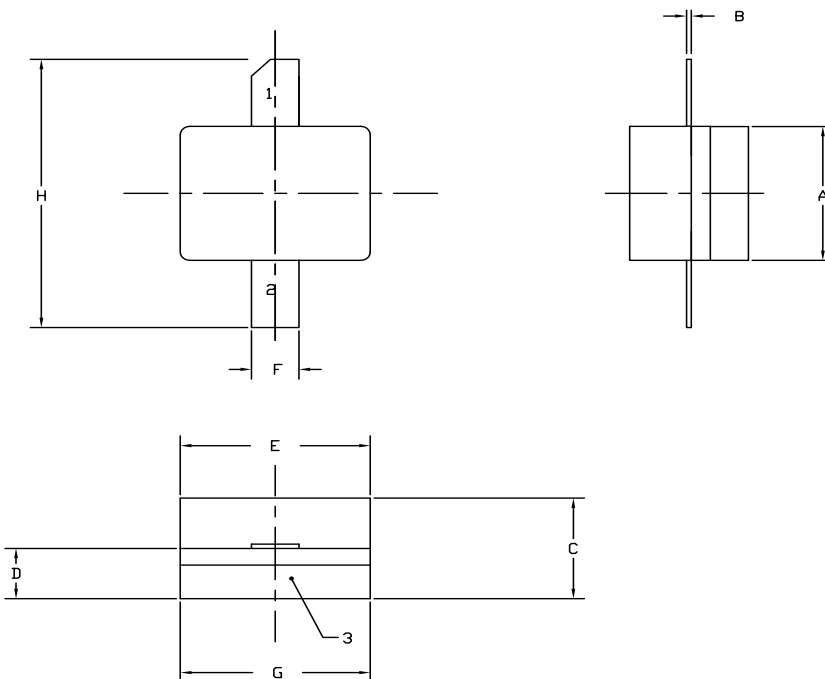



NOTES:

1. DIMENSIONING AND TOLERANCING PER ANSI Y14.5M, 1982.
2. CONTROLLING DIMENSION: INCH.
3. ADHESIVE FROM LID MAY EXTEND A MAXIMUM OF 0.020" BEYOND EDGE OF LID.
4. LID MAY BE MISALIGNED TO THE BODY OF THE PACKAGE BY A MAXIMUM OF 0.008" IN ANY DIRECTION.
5. ALL PLATED SURFACES ARE NI/AU

DIM	INCHES		MILLIMETERS	
	MIN	MAX	MIN	MAX
A	0.155	0.165	3.94	4.19
B	0.003	0.006	0.10	0.15
C	0.115	0.135	2.92	3.17
D	0.057	0.067	1.45	1.70
E	0.195	0.205	4.95	5.21
F	0.045	0.055	1.14	1.40
G	0.195	0.205	4.95	5.21
H	0.280	0.360	7.11	9.14

- PIN 1. GATE
 PIN 2. DRAIN
 PIN 3. SOURCE

Product Ordering Information

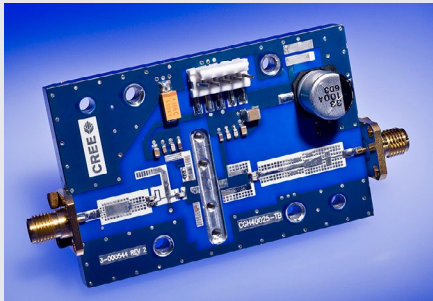
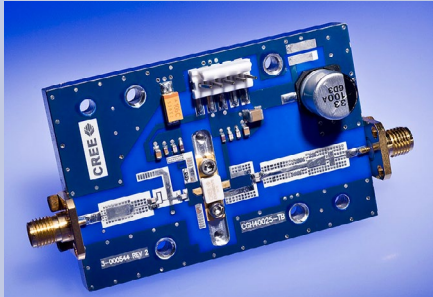
Order Number	Description	Unit of Measure	Image
CG2H40025F	GaN HEMT	Each	
CG2H40025P	GaN HEMT	Each	
CG2H40025F-TB	Test board without GaN HEMT	Each	
CG2H40025F-AMP	Test board with GaN HEMT installed	Each	



Disclaimer

Specifications are subject to change without notice. Cree, Inc. believes the information contained within this data sheet to be accurate and reliable. However, no responsibility is assumed by Cree for any infringement of patents or other rights of third parties which may result from its use. No license is granted by implication or otherwise under any patent or patent rights of Cree. Cree makes no warranty, representation or guarantee regarding the suitability of its products for any particular purpose. "Typical" parameters are the average values expected by Cree in large quantities and are provided for information purposes only. These values can and do vary in different applications and actual performance can vary over time. All operating parameters should be validated by customer's technical experts for each application. Cree products are not designed, intended or authorized for use as components in applications intended for surgical implant into the body or to support or sustain life, in applications in which the failure of the Cree product could result in personal injury or death or in applications for planning, construction, maintenance or direct operation of a nuclear facility.

For more information, please contact:

Cree, Inc.
4600 Silicon Drive
Durham, North Carolina, USA 27703
www.cree.com/RF

Sarah Miller
Marketing & Export
Cree, RF Components
1.919.407.5302

Ryan Baker
Marketing
Cree, RF Components
1.919.407.7816

Tom Dekker
Sales Director
Cree, RF Components
1.919.407.5639